

KenTIP™ Modulares Bohrer-System

Haupteinsatzbereich

Das KenTIP Modulare Bohrer-System bietet ein Leistungsniveau, das gewöhnlich mit Vollhartmetallbohrern erreicht wird. Der patentierte Spanmechanismus ermöglicht den Austausch von Schneidkörpern in der Werkzeugmaschine. Verwenden Sie KenTIP für Stahl, Gusseisen, Sphäroguss und nicht rostenden Stahl.

Eigenschaften und Vorteile

HP Bohrerstirngeometrie

- Geringe Axialkraft verhindert die Werkstückdurchbiegung.
- Sehr gute Eigenzentrierfähigkeit.
- NEU HPC(M) für Gusseisenanwendungen.
- NEU HPL(M) für nicht rostenden Stahl.

Einfacher Schneidkörperwechsel

- Einzigartiger Spanmechanismus macht Schrauben und Klemmen überflüssig.
- Schneidkörper können mit einem einfachen mitgelieferten Montage-Schlüssel werden.
- Grundkörper muss nicht aus der Maschine oder dem Spannfutter entfernt werden, um die Schneidkörper zu wechseln.

Einweg

- Keine Wiederaufbereitungskosten.
- Konstante Leistung von Bohrer zu Bohrer.
- Geringerer Werkzeugbestand, da der Nachschleif-Umlaufbestand wegfällt.

Maßgeschneiderte Schneidstoffe und Geometrien

- Der Schneidstoff KC7315™ hat eine TiAlN-basierte PVD-Beschichtung, die erstklassige Leistung für alle Stahlanwendungen bietet.
- Der Schneidstoff KC7320™ hat eine AlTiN-basierte PVD-Beschichtung, die für die Ansprüche beim Bohren von nicht rostendem Stahl entwickelt wurde.
- Der Schneidstoff KC7410™ hat eine Mehrlagen-PVD-Beschichtung, welche hervorragende Verschleißfestigkeit beim Bohren von Gusseisen bietet. Die Geometrie verhindert Gussausbrüche beim Bohren von Durchgangsbohrungen.

Sonderlösungen

- Zwischenabmessungen als Semistandard erhältlich.
- Schneidkörper für Präzisionsbohrungen mit engen Toleranzen.
- als Faswerkzeug mit Wendeplatten erhältlich.
- als Stufenbohrer erhältlich.



Modulare Bohrer Vollhartmetall-Schneidkörper - KentIP™ - HP(M) Geometrie - Schneidstoff KC7315™ - Innenkühlung

Startwert	Schnittgeschwindigkeit										Werkzeugdurchmesser										
	sfm		49	98	164	262	328	394	492	656	820	984	1148	Zoll	0.315	0.394	0.472	0.551	0.630	0.787	
	m/min		15	30	50	80	100	120	150	200	250	300	350	mm	8,0	10,0	12,0	14,0	16,0	20,0	
P1 Niedrig Kohlenstoffhaltiger Stahl, langspanend Gehalt: C < 0,25% Zugfestigkeit RM (MPa)*: <530 Härte (HB): <125																					
Vorschub																					
410					262			558					ipr	.004 - .008	.005 - .010	.006 - .012	.007 - .015	.007 - .018	.010 - .019		
125	m/min				90			170					mm/r	0,11 - 0,20	0,13 - 0,25	0,14 - 0,31	0,17 - 0,39	0,19 - 0,45	0,25 - 0,48		
P2 Niedrig Kohlenstoffhaltiger Stahl, Automatenstahl und kurzspanender Stahl Gehalt: C < 0,25% Zugfestigkeit RM (MPa)*: <650 Härte (HB): <220																					
Vorschub																					
459					345			591					ipr	.004 - .009	.005 - .011	.006 - .013	.007 - .014	.007 - .018	.010 - .019		
140	m/min				105			180					mm/r	0,11 - 0,24	0,13 - 0,29	0,14 - 0,33	0,17 - 0,36	0,19 - 0,45	0,25 - 0,48		
P3 hoch und mittel C-haltiger Kohlenstoffstahl, niedrig legierter Stahl Gehalt: C > 0,25% Zugfestigkeit RM (MPa)*: 600-850 Härte (HB): <330																					
Vorschub																					
246				164	328								ipr	.004 - .011	.005 - .014	.006 - .015	.008 - .018	.009 - .018	.012 - .020		
75	m/min			50	100								mm/r	0,11 - 0,28	0,12 - 0,35	0,16 - 0,37	0,21 - 0,46	0,23 - 0,46	0,30 - 0,51		
P4 Legierungsstahl, hochfeste C-Stähle und Werkzeugstähle Gehalt: C > 0,25% Zugfestigkeit RM (MPa)*: 800-1100 Härte (HB): 350-450																					
Vorschub																					
246				164	328								ipr	.004 - .011	.005 - .014	.006 - .015	.007 - .018	.007 - .018	.009 - .018		
75	m/min			50	100								mm/r	0,11 - 0,28	0,12 - 0,35	0,16 - 0,37	0,17 - 0,46	0,18 - 0,46	0,23 - 0,46		
K1 Grauguss und weiche Sphärogusseisen Zugfestigkeit RM (MPa)*: 150-400 Härte (HB): 120-290																					
Vorschub																					
312				197	558								ipr	.006 - .011	.006 - .013	.007 - .014	.008 - .017	.010 - .019	.012 - .023		
95	m/min			60	170								mm/r	0,15 - 0,29	0,16 - 0,32	0,17 - 0,35	0,21 - 0,42	0,25 - 0,48	0,31 - 0,59		
K2 Niedrig und mittelfester GGV und Kugelgraphitguss Zugfestigkeit RM (MPa): 400-600 Härte (HB): 130-260																					
Vorschub																					
246				197	295								ipr	.006 - .011	.006 - .012	.007 - .013	.008 - .016	.010 - .019	.012 - .023		
75	m/min			60	90								mm/r	0,15 - 0,29	0,16 - 0,30	0,17 - 0,33	0,21 - 0,41	0,25 - 0,48	0,31 - 0,59		
K3 Hochfester Kugelgraphitguss und ADI Zugfestigkeit RM (MPa): 600-900 Härte (HB): 180-350																					
Vorschub																					
213				131	295								ipr	.006 - .012	.007 - .013	.007 - .014	.008 - .016	.008 - .017	.009 - .019		
65	m/min			40	90								mm/r	0,16 - 0,30	0,17 - 0,33	0,18 - 0,36	0,20 - 0,41	0,21 - 0,44	0,23 - 0,48		

* 1 MPa = 145 psi

*HINWEIS: HP(M) ist die Alternative Wahl für die neue HPC(M) Geometrie für Gusseisenwendungen K1, K2, K3. Siehe B15

VOLLHARTMETALL-BOHRER

MODULARE BOHRER

KOMBINATIONEN WERKZEUGE

HSS UND HARTMETALL-GEWINDEBOHRER

WENDEPLATTEN-BOHRER

SENKWERKZEUGE

BOHRUNGS-FEINBEARBEITUNG

SCHNEIDPLATTEN

TECHNISCHE DATEN

INDEX

Schnittdatenempfehlungen

Modularer Bohrer Vollhartmetall-Schneidkörper - KentIP™ - HPC(M) Geometrie - Schneidstoff KC7410™ - Innenkühlung

Startwert	Schnittgeschwindigkeit										Werkzeughdurchmesser									
	sfm		49	98	164	262	328	394	492	656	820	984	1148	Zoll	0.315	0.394	0.472	0.551	0.630	0.787
	m/min		15	30	50	80	100	120	150	200	250	300	350	mm	8,0	10,0	12,0	14,0	16,0	20,0
K1 Grauguss und weiche Sphärogusseisen Zugfestigkeit RM (MPa)*: 150-400 Härte (HB): 120-290																				
Vorschub																				
574					328		656						ipr	.006 - .013	.006 - .015	.007 - .017	.009 - .019	.010 - .022	.012 - .024	
175	m/min				100		200						mm/r	0,14 - 0,32	0,16 - 0,37	0,19 - 0,43	0,23 - 0,48	0,26 - 0,55	0,30 - 0,61	
K2 Niedrig und mittelfester GGV und Kugelgraphitguss Zugfestigkeit RM (MPa): 400-600 Härte (HB): 130-260																				
Vorschub																				
525					328		591						ipr	.006 - .013	.006 - .015	.007 - .017	.009 - .019	.010 - .022	.012 - .024	
160	m/min				100		180						mm/r	0,14 - 0,32	0,16 - 0,37	0,19 - 0,43	0,23 - 0,48	0,26 - 0,55	0,30 - 0,61	
K3 Hochfester Kugelgraphitguss und ADI Zugfestigkeit RM (MPa): 600-900 Härte (HB): 180-350																				
Vorschub																				
279			230		328								ipr	.005 - .010	.006 - .012	.007 - .014	.007 - .016	.008 - .017	.011 - .020	
65	m/min		70		100								mm/r	0,13 - 0,26	0,15 - 0,31	0,17 - 0,35	0,19 - 0,40	0,21 - 0,44	0,28 - 0,51	

* 1 Mpa = 145 psi

Modularer Bohrer Vollhartmetall-Schneidkörper - KentIP™ - HPL(M) Geometrie - Schneidstoff KC7320™ - Innenkühlung

Startwert	Schnittgeschwindigkeit										Werkzeughdurchmesser									
	sfm		49	98	164	262	328	394	492	656	820	984	1148	Zoll	0.315	0.394	0.472	0.551	0.630	0.787
	m/min		15	30	50	80	100	120	150	200	250	300	350	mm	8,0	10,0	12,0	14,0	16,0	20,0
M1 Austenitischer rostfreier Stahl Gehalt: C = 0,05% - 0,15% Zugfestigkeit RM (MPa)*: <650 Härte (HB): 130-200																				
Vorschub																				
182			164		295								ipr	.002 - .004	.003 - .005	.004 - .006	.004 - .006	.004 - .007	.005 - .008	
60	m/min		50		90								mm/r	0,06 - 0,11	0,08 - 0,13	0,09 - 0,14	0,10 - 0,15	0,11 - 0,17	0,13 - 0,20	
M2 Hochfester austenitischer Stahl und rostfreier Stahlguss Gehalt: C = 0,05% - 0,15% Zugfestigkeit RM (MPa)*: 500-700 Härte (HB) : 150-230																				
Vorschub																				
152			98		295								ipr	.002 - .004	.003 - .005	.004 - .006	.004 - .006	.004 - .007	.005 - .008	
50	m/min		30		90								mm/r	0,06 - 0,11	0,08 - 0,13	0,09 - 0,14	0,10 - 0,15	0,11 - 0,17	0,13 - 0,20	
M3 Duplex-Stähle Gehalt: C = 0,05 - 0,2% Zugfestigkeit RM (MPa)*: <900 Härte (HB): 135-275																				
Vorschub																				
121			66		197								ipr	.002 - .004	.003 - .005	.004 - .006	.004 - .006	.004 - .007	.005 - .008	
40	m/min		20		60								mm/r	0,06 - 0,11	0,08 - 0,13	0,09 - 0,14	0,10 - 0,15	0,11 - 0,17	0,13 - 0,20	

* 1 MPa = 145 psi

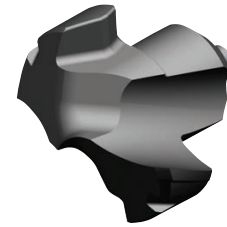
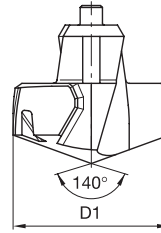

Toleranzen

D1 metrisch	Toleranz k8	D1 Zoll	Toleranz k8
8 bis 10	0,000/+0,022	0,3125 bis 0,3906	.000/+.0009
>10 bis 17	0,000/+0,027	>0,3906 bis 0,6250	0,000/+0,0011
>17 bis 18	0,000/+0,027	>0,6692 bis 0,7090	0,000/+0,0010
>18 bis 21	0,000/+0,033	>0,7090 bis 0,8228	.000/+.0013

H	■	○
S	■	○
N	■	○
K	■	○
M	■	○
P	■	○

● Erste Wahl

○ Alternative Wahl

■ KTIP HP(M)

D1		Bestellnummer	ISO Katalognummer	ANSI Katalognummer	Plattensitzgröße/Serie	KC7315
mm	Zoll					
7,94	.3125	2269793	KTIP0794HPM	KTIP03125HP	F	●
8,00	.3150	2258306	KTIP0800HPM	KTIP0800HPM	F	●
8,10	.3189	2268550	KTIP0810HPM	KTIP0810HPM	F	●
8,16	.3214	2269753	KTIP0816HPM	KTIP03214HP	F	●
8,20	.3230	2269754	KTIP0820HPM	KTIP03230HP	F	●
8,30	.3268	2268551	KTIP0830HPM	KTIP0830HPM	F	●
8,33	.3281	2269755	KTIP0833HPM	KTIP03281HP	F	●
8,40	.3307	2268552	KTIP0840HPM	KTIP0840HPM	F	●
8,43	.3320	2269756	KTIP0843HPM	KTIP03320HP	F	●
8,50	.3346	2268973	KTIP0850HPM	KTIP0850HPM	G	●
8,60	.3386	2268974	KTIP0860HPM	KTIP0860HPM	G	●
8,61	.3390	2269757	KTIP0861HPM	KTIP03390HP	G	●
8,70	.3425	2268975	KTIP0870HPM	KTIP0870HPM	G	●
8,73	.3438	2269758	KTIP0873HPM	KTIP03438HP	G	●
8,80	.3465	2268976	KTIP0880HPM	KTIP0880HPM	G	●
8,84	.3480	2269759	KTIP0884HPM	KTIP03480HP	G	●
8,90	.3504	2268977	KTIP0890HPM	KTIP0890HPM	G	●
9,00	.3543	2268978	KTIP0900HPM	KTIP0900HPM	H	●
9,09	.3580	2269760	KTIP0909HPM	KTIP03580HP	H	●
9,10	.3583	2268979	KTIP0910HPM	KTIP0910HPM	H	●
9,13	.3594	2269761	KTIP0913HPM	KTIP03594HP	H	●
9,20	.3622	2268980	KTIP0920HPM	KTIP0920HPM	H	●
9,30	.3661	2268981	KTIP0930HPM	KTIP0930HPM	H	●
9,35	.3680	2269762	KTIP0935HPM	KTIP03680HP	H	●
9,40	.3701	2268982	KTIP0940HPM	KTIP0940HPM	H	●
9,50	.3740	2268983	KTIP0950HPM	KTIP0950HPM	I	●
9,53	.3750	2269763	KTIP0953HPM	KTIP03750HP	I	●
9,56	.3763	2269764	KTIP0956HPM	KTIP03763HP	I	●
9,58	.3770	2269765	KTIP0958HPM	KTIP03770HP	I	●
9,60	.3780	2268984	KTIP0960HPM	KTIP0960HPM	I	●
9,70	.3819	2269766	KTIP0970HPM	KTIP03820HP	I	●
9,80	.3858	2269767	KTIP0980HPM	KTIP03860HP	I	●
9,90	.3898	2268985	KTIP0990HPM	KTIP0990HPM	I	●
9,92	.3906	2269768	KTIP0992HPM	KTIP03906HP	I	●
10,00	.3937	2258307	KTIP1000HPM	KTIP1000HPM	J	●
10,02	.3946	2269769	KTIP1002HPM	KTIP03946HP	J	●
10,08	.3970	2269770	KTIP1008HPM	KTIP03970HP	J	●
10,10	.3976	2268986	KTIP1010HPM	KTIP1010HPM	J	●
10,20	.4016	2268987	KTIP1020HPM	KTIP1020HPM	J	●
10,26	.4040	2269771	KTIP1026HPM	KTIP04040HP	J	●
10,30	.4055	2268988	KTIP1030HPM	KTIP1030HPM	J	●
10,32	.4062	2269772	KTIP1032HPM	KTIP04062HP	J	●

(Fortsetzung nächste Seite)

KenTIP™ Vollhartmetall-Schneidkörper – Metrisch und Zoll

VOLLHARTMETALL-BOHRER

MODULARE BOHRER

KOMBINATIONSWERKZEUGE

HSS UND HARTMETALL-GEWINDEBOHRER

WENDEPLATTEN-BOHRER

SENKWERKZEUGE

BOHRUNGS-FEINBEARBEITUNG

SCHNEIDPLATTEN

TECHNISCHE DATEN

INDEX

■ KTIP HP(M)

(Fortsetzung von voriger Seite)

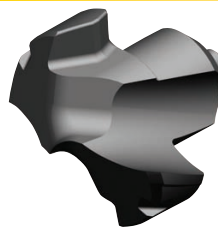
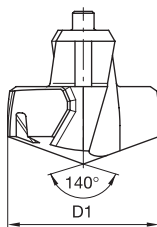

- Erste Wahl
- Alternative Wahl

H	■	■
S	■	■
N	■	■
K	■	○
M	■	■
P	■	●

D1		Bestellnummer	ISO Katalognummer	ANSI Katalognummer	Plattensitzgröße/Serie	KC7315
mm	Zoll					
10,40	.4094	2240041	KTIP1040HPM	KTIP1040HPM	J	●
10,49	.4130	2269773	KTIP1049HPM	KTIP04130HP	J	●
10,50	.4134	2268989	KTIP1050HPM	KTIP1050HPM	K	●
10,60	.4173	2268990	KTIP1060HPM	KTIP1060HPM	K	●
10,70	.4213	2268991	KTIP1070HPM	KTIP1070HPM	K	●
10,72	.4219	2269774	KTIP1072HPM	KTIP04219HP	K	●
10,80	.4252	2268992	KTIP1080HPM	KTIP1080HPM	K	●
10,90	.4291	2268993	KTIP1090HPM	KTIP1090HPM	K	●
11,00	.4331	2268994	KTIP1100HPM	KTIP1100HPM	L	●
11,10	.4370	2268995	KTIP1110HPM	KTIP1110HPM	L	●
11,11	.4375	2269775	KTIP1111HPM	KTIP04375HP	L	●
11,20	.4409	2268996	KTIP1120HPM	KTIP1120HPM	L	●
11,30	.4449	2254192	KTIP1130HPM	KTIP1130HPM	L	●
11,40	.4488	2268997	KTIP1140HPM	KTIP1140HPM	L	●
11,50	.4528	2268998	KTIP1150HPM	KTIP1150HPM	M	●
11,51	.4531	2269776	KTIP1151HPM	KTIP04531HP	M	●
11,60	.4567	2268999	KTIP1160HPM	KTIP1160HPM	M	●
11,61	.4571	2269777	KTIP1161HPM	KTIP04571HP	M	●
11,70	.4606	2269000	KTIP1170HPM	KTIP1170HPM	M	●
11,80	.4646	2269001	KTIP1180HPM	KTIP1180HPM	M	●
11,90	.4685	2269002	KTIP1190HPM	KTIP1190HPM	M	●
11,91	.4688	2269778	KTIP1191HPM	KTIP04688HP	M	●
12,00	.4724	2258308	KTIP1200HPM	KTIP1200HPM	N	●
12,10	.4764	2269003	KTIP1210HPM	KTIP1210HPM	N	●
12,20	.4803	2269004	KTIP1220HPM	KTIP1220HPM	N	●
12,30	.4843	2269779	KTIP1230HPM	KTIP04844HP	N	●
12,40	.4882	2269005	KTIP1240HPM	KTIP1240HPM	N	●
12,47	.4911	2269780	KTIP1247HPM	KTIP04911HP	N	●
12,50	.4921	2269006	KTIP1250HPM	KTIP1250HPM	O	●
12,60	.4961	2269007	KTIP1260HPM	KTIP1260HPM	O	●
12,70	.5000	2269781	KTIP1270HPM	KTIP05000HP	O	●
12,80	.5039	2491380	KTIP1280HPM	KTIP1280HPM	O	●
12,90	.5080	2269782	KTIP1290HPM	KTIP05080HP	O	●
13,00	.5118	2266152	KTIP1300HPM	KTIP1300HPM	P	●
13,10	.5156	2269783	KTIP1310HPM	KTIP05156HP	P	●
13,20	.5197	2610194	KTIP1320HPM	KTIP1320HPM	P	●
13,30	.5236	2269008	KTIP1330HPM	KTIP1330HPM	P	●
13,40	.5276	2641557	KTIP1340HPM	KTIP1340HPM	P	●
13,49	.5312	2269784	KTIP1349HPM	KTIP05312HP	P	●
13,50	.5315	2269009	KTIP1350HPM	KTIP1350HPM	Q	●
13,60	.5354	2630538	KTIP1360HPM	KTIP1360HPM	Q	●
13,70	.5394	2396961	KTIP1370HPM	KTIP1370HPM	Q	●
13,80	.5433	2419341	KTIP1380HPM	KTIP1380HPM	Q	●
13,89	.5469	2269785	KTIP1389HPM	KTIP05469HP	Q	●
13,90	.5471	2269786	KTIP1390HPM	KTIP05471HP	Q	●
14,00	.5512	2269010	KTIP1400HPM	KTIP1400HPM	R	●
14,10	.5551	2401860	KTIP1410HPM	KTIP1410HPM	R	●
14,20	.5591	2269011	KTIP1420HPM	KTIP1420HPM	R	●
14,29	.5625	2269787	KTIP1429HPM	KTIP05625HP	R	●
14,30	.5630	2269012	KTIP1430HPM	KTIP1430HPM	R	●

(Fortsetzung nächste Seite)

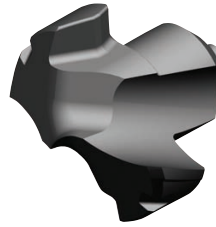

H	■
S	■
N	■
K	○
M	■
P	●

- Erste Wahl
- Alternative Wahl

■ KTIP HP(M)

(Fortsetzung von voriger Seite)

D1		Bestellnummer	ISO Katalognummer	ANSI Katalognummer	Plattensitzgröße/Serie	KC7315
mm	Zoll					
14,40	.5669	2401211	KTIP1440HPM	KTIP1440HPM	R	●
14,50	.5709	2269013	KTIP1450HPM	KTIP1450HPM	S	●
14,60	.5748	2398855	KTIP1460HPM	KTIP1460HPM	S	●
14,67	.5774	2269788	KTIP1467HPM	KTIP05774HP	S	●
14,68	.5781	2269789	KTIP1468HPM	KTIP05781HP	S	●
14,70	.5787	2269014	KTIP1470HPM	KTIP1470HPM	S	●
14,80	.5827	2269015	KTIP1480HPM	KTIP1480HPM	S	●
14,90	.5866	2646798	KTIP1490HPM	KTIP1490HPM	S	●
15,00	.5906	2269016	KTIP1500HPM	KTIP1500HPM	T	●
15,08	.5938	2269790	KTIP1508HPM	KTIP05938HP	T	●
15,10	.5945	2646799	KTIP1510HPM	KTIP1510HPM	T	●
15,20	.5984	2646800	KTIP1520HPM	KTIP1520HPM	T	●
15,30	.6024	2269017	KTIP1530HPM	KTIP1530HPM	T	●
15,40	.6063	2488572	KTIP1540HPM	KTIP1540HPM	T	●
15,48	.6094	2269791	KTIP1548HPM	KTIP06094HP	T	●
15,50	.6102	2269018	KTIP1550HPM	KTIP1550HPM	T	●
15,60	.6142	2459124	KTIP1560HPM	KTIP1560HPM	T	●
15,70	.6181	2269019	KTIP1570HPM	KTIP1570HPM	T	●
15,80	.6220	2269020	KTIP1580HPM	KTIP1580HPM	T	●
15,88	.6250	2269792	KTIP1588HPM	KTIP06250HP	T	●
16,00	.6300	2258309	KTIP1600HPM	KTIP1600HPM	U	●
16,03	.6310	2646801	KTIP1603HPM	KTIP06310HP	U	●
16,08	.6330	2646802	KTIP1608HPM	KTIP06330HP	U	●
16,10	.6339	2448304	KTIP1610HPM	KTIP1610HPM	U	●
16,20	.6378	2496158	KTIP1620HPM	KTIP1620HPM	U	●
16,27	.6406	2646923	KTIP1627HPM	KTIP06406HP	U	●
16,30	.6417	2611859	KTIP1630HPM	KTIP1630HPM	U	●
16,40	.6457	2646924	KTIP1640HPM	KTIP1640HPM	U	●
16,50	.6496	2504824	KTIP1650HPM	KTIP1650HPM	U	●
16,60	.6535	2619484	KTIP1660HPM	KTIP1660HPM	U	●
16,67	.6562	2611860	KTIP1667HPM	KTIP06562HP	U	●
16,70	.6575	2623676	KTIP1670HPM	KTIP1670HPM	U	●
16,80	.6614	2646925	KTIP1680HPM	KTIP1680HPM	U	●
16,87	.6643	2646926	KTIP1687HPM	KTIP06643HP	U	●
16,90	.6654	2646927	KTIP1690HPM	KTIP1690HPM	U	●
17,00	.6692	2983124	KTIP1700HPM	KTIP1700HPM	V	●
17,07	.6719	2983125	KTIP1707HPM	KTIP06719HP	V	●
17,10	.6732	2983126	KTIP1710HPM	KTIP1710HPM	V	●
17,20	.6772	2983127	KTIP1720HPM	KTIP1720HPM	V	●
17,30	.6811	2983128	KTIP1730HPM	KTIP1730HPM	V	●
17,40	.6850	2983129	KTIP1740HPM	KTIP1740HPM	V	●
17,46	.6875	2983130	KTIP1748HPM	KTIP06875HP	V	●
17,50	.6890	2983131	KTIP1750HPM	KTIP1750HPM	V	●
17,60	.6929	2983132	KTIP1760HPM	KTIP1760HPM	V	●
17,70	.6969	2983283	KTIP1770HPM	KTIP1770HPM	V	●
17,80	.7008	2983284	KTIP1780HPM	KTIP1780HPM	V	●
17,86	.7031	2983285	KTIP1786HPM	KTIP07031HP	V	●
17,90	.7047	2983286	KTIP1790HPM	KTIP1790HPM	V	●
18,00	.7087	2983287	KTIP1800HPM	KTIP1800HPM	W	●
18,10	.7126	2983288	KTIP1810HPM	KTIP1810HPM	W	●

(Fortsetzung nächste Seite)

VOLLHARTMETALL-BOHRER
MODULARE BOHRER
KOMBINATIONSWERKZEUGE
HSS UND HARTMETALL-GEWINDEBOHRER
WECHSELPLATTEN-BOHRER
SENKWERKZEUGE
BOHRUNGSFEINBEARBEITUNG
SCHNEIDPLATTEN
TECHNISCHE DATEN
INDEX

KenTIP™ Vollhartmetall-Schneidkörper – Metrisch und Zoll

VOLLHARTMETALL-BOHRER

MODULARE BOHRER

KOMBINATIONSWERKZEUGE

HSS UND HARTMETALL-GEWINDEBOHRER

WENDEPLATTEN-BOHRER

SENKWERKZEUGE

BOHRUNGS-FEINBEARBEITUNG

SCHNEIDPLATTEN

TECHNISCHE DATEN

INDEX

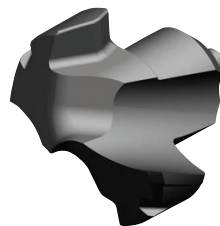
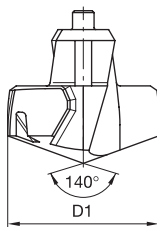

- Erste Wahl
- Alternative Wahl

H	■	□
S	■	□
N	■	□
K	■	○
M	■	□
P	■	●

KTIP HP(M)

(Fortsetzung von voriger Seite)

D1		Bestellnummer	ISO	ANSI	Plattensitzgröße/Serie	KC7315
mm	Zoll		Katalognummer	Katalognummer		
18,20	.7165	2983289	KTIP1820HPM	KTIP1820HPM	W	●
18,26	.7188	2983290	KTIP1826HPM	KTIP07188HP	W	●
18,30	.7205	2983291	KTIP1830HPM	KTIP1830HPM	W	●
18,40	.7244	2983292	KTIP1840HPM	KTIP1840HPM	W	●
18,50	.7283	2983293	KTIP1850HPM	KTIP1850HPM	W	●
18,60	.7323	2983294	KTIP1860HPM	KTIP1860HPM	W	●
18,65	.7344	2983295	KTIP1864HPM	KTIP07344HP	W	●
18,70	.7362	2983296	KTIP1870HPM	KTIP1870HPM	W	●
18,80	.7402	2983297	KTIP1880HPM	KTIP1880HPM	W	●
18,90	.7441	2983298	KTIP1890HPM	KTIP1890HPM	W	●
19,00	.7480	2983299	KTIP1900HPM	KTIP1900HPM	X	●
19,05	.7500	2983300	KTIP1905HPM	KTIP07500HP	X	●
19,10	.7520	2983301	KTIP1910HPM	KTIP1910HPM	X	●
19,20	.7559	2983302	KTIP1920HPM	KTIP1920HPM	X	●
19,23	.7570	2983326	KTIP1923HPM	KTIP07570HP	X	●
19,25	.7580	2983303	KTIP1925HPM	KTIP07580HP	X	●
19,28	.7590	2983304	KTIP1928HPM	KTIP07590HP	X	●
19,30	.7598	2983305	KTIP1930HPM	KTIP1930HPM	X	●
19,35	.7620	2983327	KTIP1935HPM	KTIP07620HP	X	●
19,40	.7638	2983306	KTIP1940HPM	KTIP1940HPM	X	●
19,45	.7656	2983307	KTIP1946HPM	KTIP07656HP	X	●
19,50	.7677	2983308	KTIP1950HPM	KTIP1950HPM	X	●
19,60	.7717	2983309	KTIP1960HPM	KTIP1960HPM	X	●
19,70	.7756	2983310	KTIP1970HPM	KTIP1970HPM	X	●
19,80	.7795	2983311	KTIP1980HPM	KTIP1980HPM	X	●
19,84	.7812	2983312	KTIP1984HPM	KTIP07812HP	X	●
19,90	.7835	2983313	KTIP1990HPM	KTIP1990HPM	X	●
20,00	.7874	2983314	KTIP2000HPM	KTIP2000HPM	Y	●
20,10	.7913	2983315	KTIP2010HPM	KTIP2010HPM	Y	●
20,20	.7953	2983316	KTIP2020HPM	KTIP2020HPM	Y	●
20,24	.7969	2983317	KTIP2024HPM	KTIP07969HP	Y	●
20,30	.7992	2983318	KTIP2030HPM	KTIP2030HPM	Y	●
20,40	.8031	2983319	KTIP2040HPM	KTIP2040HPM	Y	●
20,50	.8071	2983320	KTIP2050HPM	KTIP2050HPM	Y	●
20,60	.8110	2983321	KTIP2060HPM	KTIP2060HPM	Y	●
20,64	.8125	2983322	KTIP2064HPM	KTIP08125HP	Y	●
20,70	.8150	2983323	KTIP2070HPM	KTIP2070HPM	Y	●
20,80	.8189	2983324	KTIP2080HPM	KTIP2080HPM	Y	●
20,90	.8228	2983325	KTIP2090HPM	KTIP2090HPM	Y	●
20,99	.8264	3124442	KTIP2099HPM	KTIP2099HPM	Y	●

Bestellbeispiel:

Nach Katalognummer KTIP03125HPM KC7315, oder nach Bestellnummer 2269793.

Toleranzen			
D1 metrisch	Toleranz k8	D1 Zoll	Toleranz k8
8 bis 10	0,000/+0,022	0,3125 bis 0,3906	0,000/+0,0009
>10 bis 17	0,000/+0,027	>0,3906 bis 0,6250	.000/+0,0011
>17 bis 18	0,000/+0,027	>0,6692 bis 0,7090	.000/+0,0010
>18 bis 21	0,000/+0,033	>0,7090 bis 0,8228	.000/+0,0013

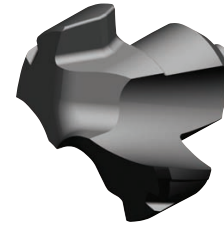
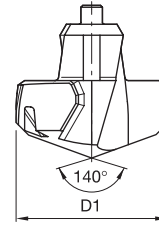

- Erste Wahl
- Alternative Wahl

H	■
S	■
N	■
K	●
M	■
P	■

■ KTIP HPC(M)

D1		Bestellnummer	ISO Katalognummer	ANSI Katalognummer	Plattensitz-Größe/serie	KC7/10
mm	Zoll					
7,94	0,3125	3578835	KTIP0794HPCM	KTIP03125HPC	F	●
8,00	0,3150	3579265	KTIP0800HPCM	KTIP0800HPCM	F	●
8,10	0,3189	3579266	KTIP0810HPCM	KTIP0810HPCM	F	●
8,20	0,3230	3578836	KTIP0820HPCM	KTIP03230HPC	F	●
8,30	0,3268	3579267	KTIP0830HPCM	KTIP0830HPCM	F	●
8,33	0,3281	3578837	KTIP0833HPCM	KTIP03281HPC	F	●
8,40	0,3307	3579268	KTIP0840HPCM	KTIP0840HPCM	F	●
8,50	0,3346	3579269	KTIP0850HPCM	KTIP0850HPCM	G	●
8,60	0,3386	3579270	KTIP0860HPCM	KTIP0860HPCM	G	●
8,70	0,3425	3579271	KTIP0870HPCM	KTIP0870HPCM	G	●
8,73	0,3438	3578838	KTIP0873HPCM	KTIP03438HPC	G	●
8,80	0,3465	3579272	KTIP0880HPCM	KTIP0880HPCM	G	●
8,90	0,3504	3579273	KTIP0890HPCM	KTIP0890HPCM	G	●
9,00	0,3543	3579274	KTIP0900HPCM	KTIP0900HPCM	H	●
9,10	0,3583	3579275	KTIP0910HPCM	KTIP0910HPCM	H	●
9,13	0,3594	3578839	KTIP0913HPCM	KTIP03594HPC	H	●
9,20	0,3622	3579276	KTIP0920HPCM	KTIP0920HPCM	H	●
9,30	0,3661	3579277	KTIP0930HPCM	KTIP0930HPCM	H	●
9,40	0,3701	3579278	KTIP0940HPCM	KTIP0940HPCM	H	●
9,50	0,3740	3579279	KTIP0950HPCM	KTIP0950HPCM	I	●
9,53	0,3750	3578840	KTIP0953HPCM	KTIP03750HPC	I	●
9,56	0,3763	3578841	KTIP0956HPCM	KTIP03763HPC	I	●
9,60	0,3780	3579280	KTIP0960HPCM	KTIP0960HPCM	I	●
9,70	0,3820	3578842	KTIP0970HPCM	KTIP03820HPC	I	●
9,80	0,3860	3578913	KTIP0980HPCM	KTIP03860HPC	I	●
9,90	0,3898	3579281	KTIP0990HPCM	KTIP0990HPCM	I	●
9,92	0,3906	3578914	KTIP0992HPCM	KTIP03906HPC	I	●
10,00	0,3937	3579282	KTIP1000HPCM	KTIP1000HPCM	J	●
10,02	0,3946	3578915	KTIP1002HPCM	KTIP03946HPC	J	●
10,10	0,3976	3579283	KTIP1010HPCM	KTIP1010HPCM	J	●
10,20	0,4016	3579284	KTIP1020HPCM	KTIP1020HPCM	J	●
10,26	0,4040	3578916	KTIP1026HPCM	KTIP04040HPC	J	●
10,30	0,4055	3579285	KTIP1030HPCM	KTIP1030HPCM	J	●
10,32	0,4062	3578917	KTIP1032HPCM	KTIP04062HPC	J	●
10,40	0,4094	3579286	KTIP1040HPCM	KTIP1040HPCM	J	●
10,49	0,4130	3578918	KTIP1049HPCM	KTIP04130HPC	J	●
10,50	0,4134	3579287	KTIP1050HPCM	KTIP1050HPCM	K	●
10,60	0,4173	3579288	KTIP1060HPCM	KTIP1060HPCM	K	●
10,70	0,4213	3579289	KTIP1070HPCM	KTIP1070HPCM	K	●
10,72	0,4219	3578919	KTIP1072HPCM	KTIP04219HPC	K	●
10,80	0,4252	3579290	KTIP1080HPCM	KTIP1080HPCM	K	●
10,90	0,4291	3579291	KTIP1090HPCM	KTIP1090HPCM	K	●

(Fortsetzung nächste Seite)

VOLLHARTMETALL-BOHRER

MODULARE BOHRER

KOMBINATIONEN WERKZEUGE

HSS UND HARTMETALL-GEWINDEBOHRER

WENDEPLATTEN-BOHRER

SENKWERKZEUGE

BOHRUNGS-FEINBEARBEITUNG

SCHNEIDPLATTEN

TECHNISCHE DATEN

INDEX

KTIP HPC(M)

(Fortsetzung von voriger Seite)

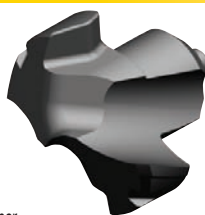

● Erste Wahl

○ Alternative Wahl

H	■	■
S	■	■
N	■	■
K	■	●
M	■	■
P	■	■

D1	mm		Zoll	Bestellnummer	ISO	Katalognummer	ANSI	Katalognummer	Plattensitz-Größe/serie	KC7410
11,00		0,4331		3579292	KTIP1100HPCM	KTIP1100HPCM		KTIP1100HPCM	L	●
11,10		0,4370		3579293	KTIP1110HPCM	KTIP1110HPCM		KTIP1110HPCM	L	●
11,11		0,4375		3578920	KTIP1111HPCM	KTIP04375HPC		KTIP04375HPC	L	●
11,20		0,4409		3579294	KTIP1120HPCM	KTIP1120HPCM		KTIP1120HPCM	L	●
11,30		0,4449		3579295	KTIP1130HPCM	KTIP1130HPCM		KTIP1130HPCM	L	●
11,40		0,4488		3579296	KTIP1140HPCM	KTIP1140HPCM		KTIP1140HPCM	L	●
11,50		0,4528		3579297	KTIP1150HPCM	KTIP1150HPCM		KTIP1150HPCM	M	●
11,51		0,4531		3578921	KTIP1151HPCM	KTIP04531HPC		KTIP04531HPC	M	●
11,60		0,4567		3579298	KTIP1160HPCM	KTIP1160HPCM		KTIP1160HPCM	M	●
11,70		0,4606		3579299	KTIP1170HPCM	KTIP1170HPCM		KTIP1170HPCM	M	●
11,80		0,4646		3579300	KTIP1180HPCM	KTIP1180HPCM		KTIP1180HPCM	M	●
11,90		0,4685		3579301	KTIP1190HPCM	KTIP1190HPCM		KTIP1190HPCM	M	●
11,91		0,4688		3578922	KTIP1191HPCM	KTIP04688HPC		KTIP04688HPC	M	●
12,00		0,4724		3579302	KTIP1200HPCM	KTIP1200HPCM		KTIP1200HPCM	N	●
12,10		0,4764		3579303	KTIP1210HPCM	KTIP1210HPCM		KTIP1210HPCM	N	●
12,20		0,4803		3579304	KTIP1220HPCM	KTIP1220HPCM		KTIP1220HPCM	N	●
12,30		0,4844		3578923	KTIP1230HPCM	KTIP04844HPC		KTIP04844HPC	N	●
12,40		0,4882		3579305	KTIP1240HPCM	KTIP1240HPCM		KTIP1240HPCM	N	●
12,50		0,4921		3579306	KTIP1250HPCM	KTIP1250HPCM		KTIP1250HPCM	O	●
12,60		0,4961		3579307	KTIP1260HPCM	KTIP1260HPCM		KTIP1260HPCM	O	●
12,70		0,5000		3578924	KTIP1270HPCM	KTIP05000HPC		KTIP05000HPC	O	●
12,80		0,5039		3579308	KTIP1280HPCM	KTIP1280HPCM		KTIP1280HPCM	O	●
12,90		0,5080		3578925	KTIP1290HPCM	KTIP05080HPC		KTIP05080HPC	O	●
13,00		0,5118		3579309	KTIP1300HPCM	KTIP1300HPCM		KTIP1300HPCM	P	●
13,10		0,5156		3578926	KTIP1310HPCM	KTIP05156HPC		KTIP05156HPC	P	●
13,20		0,5197		3579310	KTIP1320HPCM	KTIP1320HPCM		KTIP1320HPCM	P	●
13,30		0,5236		3579311	KTIP1330HPCM	KTIP1330HPCM		KTIP1330HPCM	P	●
13,40		0,5276		3579312	KTIP1340HPCM	KTIP1340HPCM		KTIP1340HPCM	P	●
13,49		0,5312		3578927	KTIP1349HPCM	KTIP05312HPC		KTIP05312HPC	P	●
13,50		0,5315		3579313	KTIP1350HPCM	KTIP1350HPCM		KTIP1350HPCM	Q	●
13,60		0,5354		3579314	KTIP1360HPCM	KTIP1360HPCM		KTIP1360HPCM	Q	●
13,70		0,5394		3579315	KTIP1370HPCM	KTIP1370HPCM		KTIP1370HPCM	Q	●
13,80		0,5433		3579316	KTIP1380HPCM	KTIP1380HPCM		KTIP1380HPCM	Q	●
13,89		0,5469		3578928	KTIP1389HPCM	KTIP05469HPC		KTIP05469HPC	Q	●
14,00		0,5512		3579317	KTIP1400HPCM	KTIP1400HPCM		KTIP1400HPCM	R	●
14,10		0,5551		3579318	KTIP1410HPCM	KTIP1410HPCM		KTIP1410HPCM	R	●
14,20		0,5591		3579319	KTIP1420HPCM	KTIP1420HPCM		KTIP1420HPCM	R	●
14,29		0,5625		3578929	KTIP1429HPCM	KTIP05625HPC		KTIP05625HPC	R	●
14,30		0,5630		3579320	KTIP1430HPCM	KTIP1430HPCM		KTIP1430HPCM	R	●
14,40		0,5669		3579321	KTIP1440HPCM	KTIP1440HPCM		KTIP1440HPCM	R	●
14,50		0,5709		3579322	KTIP1450HPCM	KTIP1450HPCM		KTIP1450HPCM	S	●
14,60		0,5748		3579323	KTIP1460HPCM	KTIP1460HPCM		KTIP1460HPCM	S	●
14,68		0,5781		3578930	KTIP1468HPCM	KTIP05781HPC		KTIP05781HPC	S	●
14,70		0,5787		3579324	KTIP1470HPCM	KTIP1470HPCM		KTIP1470HPCM	S	●
14,80		0,5827		3579325	KTIP1480HPCM	KTIP1480HPCM		KTIP1480HPCM	S	●
15,00		0,5906		3579326	KTIP1500HPCM	KTIP1500HPCM		KTIP1500HPCM	T	●
15,08		0,5938		3578931	KTIP1508HPCM	KTIP05938HPC		KTIP05938HPC	T	●
15,10		0,5945		3579327	KTIP1510HPCM	KTIP1510HPCM		KTIP1510HPCM	T	●
15,20		0,5984		3579328	KTIP1520HPCM	KTIP1520HPCM		KTIP1520HPCM	T	●
15,30		0,6024		3579329	KTIP1530HPCM	KTIP1530HPCM		KTIP1530HPCM	T	●

(Fortsetzung nächste Seite)

■ KTIP HPC(M)

(Fortsetzung von voriger Seite)

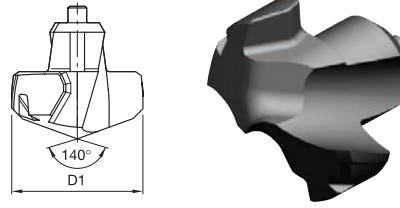

- Erste Wahl
- Alternative Wahl

H	■
S	■
N	■
K	●
M	■
P	■

D1		Bestellnummer	ISO Katalognummer	ANSI Katalognummer	Plattensitz-Größe/serie	KC7410
mm	Zoll					
15,40	0,6063	3579330	KTIP1540HPCM	KTIP1540HPCM	T	●
15,50	0,6102	3579331	KTIP1550HPCM	KTIP1550HPCM	T	●
15,60	0,6142	3579332	KTIP1560HPCM	KTIP1560HPCM	T	●
15,70	0,6181	3579333	KTIP1570HPCM	KTIP1570HPCM	T	●
15,80	0,6220	3579334	KTIP1580HPCM	KTIP1580HPCM	T	●
15,88	0,6250	3578932	KTIP1588HPCM	KTIP06250HPC	T	●
16,00	0,6299	3579335	KTIP1600HPCM	KTIP1600HPCM	U	●
16,08	0,6330	3578933	KTIP1608HPCM	KTIP06330HPC	U	●
16,10	0,6339	3579336	KTIP1610HPCM	KTIP1610HPCM	U	●
16,20	0,6378	3579337	KTIP1620HPCM	KTIP1620HPCM	U	●
16,30	0,6417	3579338	KTIP1630HPCM	KTIP1630HPCM	U	●
16,40	0,6457	3579339	KTIP1640HPCM	KTIP1640HPCM	U	●
16,50	0,6496	3579340	KTIP1650HPCM	KTIP1650HPCM	U	●
16,60	0,6535	3579341	KTIP1660HPCM	KTIP1660HPCM	U	●
16,67	0,6562	3578934	KTIP1667HPCM	KTIP06562HPC	U	●
16,70	0,6575	3579342	KTIP1670HPCM	KTIP1670HPCM	U	●
16,80	0,6614	3579343	KTIP1680HPCM	KTIP1680HPCM	U	●
16,90	0,6654	3579344	KTIP1690HPCM	KTIP1690HPCM	U	●
17,00	0,6693	3579345	KTIP1700HPCM	KTIP1700HPCM	V	●
17,10	0,6732	3579346	KTIP1710HPCM	KTIP1710HPCM	V	●
17,20	0,6772	3579347	KTIP1720HPCM	KTIP1720HPCM	V	●
17,30	0,6811	3579348	KTIP1730HPCM	KTIP1730HPCM	V	●
17,50	0,689	3579349	KTIP1750HPCM	KTIP1750HPCM	V	●
17,60	0,6929	3579350	KTIP1760HPCM	KTIP1760HPCM	V	●
17,70	0,6969	3579351	KTIP1770HPCM	KTIP1770HPCM	V	●
17,80	0,7008	3579352	KTIP1780HPCM	KTIP1780HPCM	V	●
18,00	0,7087	3579353	KTIP1800HPCM	KTIP1800HPCM	W	●
18,10	0,7126	3579354	KTIP1810HPCM	KTIP1810HPCM	W	●
18,50	0,7283	3579355	KTIP1850HPCM	KTIP1850HPCM	W	●
18,80	0,7402	3579356	KTIP1880HPCM	KTIP1880HPCM	W	●
18,90	0,7441	3579357	KTIP1890HPCM	KTIP1890HPCM	W	●
19,00	0,748	3579358	KTIP1900HPCM	KTIP1900HPCM	X	●
19,05	0,75	3578935	KTIP1905HPCM	KTIP07500HPC	X	●
19,20	0,7559	3579359	KTIP1920HPCM	KTIP1920HPCM	X	●
19,50	0,7677	3579360	KTIP1950HPCM	KTIP1950HPCM	X	●
19,60	0,7717	3579361	KTIP1960HPCM	KTIP1960HPCM	X	●
19,70	0,7756	3579362	KTIP1970HPCM	KTIP1970HPCM	X	●
19,80	0,7795	3579363	KTIP1980HPCM	KTIP1980HPCM	X	●
20,00	0,7874	3579364	KTIP2000HPCM	KTIP2000HPCM	J	●
20,10	0,7913	3579365	KTIP2010HPCM	KTIP2010HPCM	J	●
20,30	0,7992	3579366	KTIP2030HPCM	KTIP2030HPCM	J	●
20,50	0,8071	3579367	KTIP2050HPCM	KTIP2050HPCM	J	●
20,60	0,811	3579368	KTIP2060HPCM	KTIP2060HPCM	J	●
20,99	0,8264	3579369	KTIP2099HPCM	KTIP2099HPCM	J	●

Bestellbeispiel:

Nach Katalognummern KTIP1540HPCM oder KTIP1540HPCM KC7410, oder nach Bestellnummer 3579330.

VOLLHARTMETALL-BOHRER
MODULARE BOHRER
KOMBINATIONSWERKZEUGE
HSS UND HARTMETALL-GEWINDEBOHRER
WEINDEPLATTEN-BOHRER
SENKWERKZEUGE
BOHRUNGS-FEINBEARBEITUNG
SCHNEIDPLATTEN
TECHNISCHE DATEN
INDEX

VOLLHARTMETALL-BOHRER

MODULARE BOHRER

KOMBINATIONSWERKZEUGE

HSS UND HARTMETALL-GEWINDEBOHRER

WENDEPLATTEN-BOHRER

SENKWERKZEUGE

BOHRUNGSFEINBEARBEITUNG

SCHNEIDPLATTEN

TECHNISCHE DATEN

INDEX

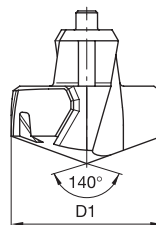

Toleranzen

D1 metrisch	Toleranz k8	D1 Zoll	Toleranz k8
8 bis 10	0,000/+0,022	0,3125 bis 0,3906	.000/+ .0009
>10 bis 17	0,000/+0,027	>0,3906 bis 0,6250	.000/+ .0011
>17 bis 18	0,000/+0,027	>0,6692 bis 0,7090	.000/+ .0010
>18 bis 21	0,000/+0,033	>0,7090 bis 0,8228	.000/+ .0013

- Erste Wahl
- Alternative Wahl

H	■	■
S	■	■
N	■	■
K	■	■
M	■	●
P	■	■

■ KTIP HPL(M)

D1		Bestellnummer	ISO-Katalognummer	ANSI-Katalognummer	Plattensitz-Größe/serie	KC7320
mm	Zoll					
7,94	0,3125	3557766	KTIP0794HPLM	KTIP03125HPL	F	●
8,00	0,3150	3548607	KTIP0800HPLM	KTIP0800HPLM	F	●
8,10	0,3189	3556387	KTIP0810HPLM	KTIP0810HPLM	F	●
8,16	0,3214	3557767	KTIP0816HPLM	KTIP03214HPL	F	●
8,20	0,3230	3557795	KTIP0820HPLM	KTIP03230HPL	F	●
8,30	0,3268	3556388	KTIP0830HPLM	KTIP0830HPLM	F	●
8,33	0,3281	3557768	KTIP0833HPLM	KTIP03281HPL	F	●
8,40	0,3307	3556389	KTIP0840HPLM	KTIP0840HPLM	F	●
8,50	0,3346	3556390	KTIP0850HPLM	KTIP0850HPLM	G	●
8,60	0,3386	3556391	KTIP0860HPLM	KTIP0860HPLM	G	●
8,70	0,3425	3556392	KTIP0870HPLM	KTIP0870HPLM	G	●
8,80	0,3465	3557623	KTIP0880HPLM	KTIP0880HPLM	G	●
8,90	0,3504	3557624	KTIP0890HPLM	KTIP0890HPLM	G	●
9,00	0,3543	3557625	KTIP0900HPLM	KTIP0900HPLM	H	●
9,10	0,3583	3557626	KTIP0910HPLM	KTIP0910HPLM	H	●
9,20	0,3622	3557627	KTIP0920HPLM	KTIP0920HPLM	H	●
9,30	0,3661	3557628	KTIP0930HPLM	KTIP0930HPLM	H	●
9,40	0,3701	3557629	KTIP0940HPLM	KTIP0940HPLM	H	●
9,50	0,3740	3557630	KTIP0950HPLM	KTIP0950HPLM	I	●
9,56	0,3763	3557769	KTIP0956HPLM	KTIP03763HPL	I	●
9,58	0,3770	3557770	KTIP0958HPLM	KTIP03770HPL	I	●
9,60	0,3780	3557631	KTIP0960HPLM	KTIP0960HPLM	I	●
9,70	0,3820	3557758	KTIP0970HPLM	KTIP03820HPL	I	●
9,80	0,3860	3557759	KTIP0980HPLM	KTIP03860HPL	I	●
9,90	0,3898	3557632	KTIP0990HPLM	KTIP0990HPLM	I	●
10,00	0,3937	3557633	KTIP1000HPLM	KTIP1000HPLM	J	●
10,02	0,3946	3557771	KTIP1002HPLM	KTIP03946HPL	J	●
10,10	0,3976	3557634	KTIP1010HPLM	KTIP1010HPLM	J	●
10,20	0,4016	3557635	KTIP1020HPLM	KTIP1020HPLM	J	●
10,30	0,4055	3557636	KTIP1030HPLM	KTIP1030HPLM	J	●
10,32	0,4062	3557772	KTIP1032HPLM	KTIP04062HPL	J	●
10,40	0,4094	3557637	KTIP1040HPLM	KTIP1040HPLM	J	●
10,50	0,4134	3557638	KTIP1050HPLM	KTIP1050HPLM	K	●
10,60	0,4173	3557639	KTIP1060HPLM	KTIP1060HPLM	K	●
10,70	0,4213	3557640	KTIP1070HPLM	KTIP1070HPLM	K	●
10,80	0,4252	3557641	KTIP1080HPLM	KTIP1080HPLM	K	●
10,90	0,4291	3557642	KTIP1090HPLM	KTIP1090HPLM	K	●
11,00	0,4331	3557643	KTIP1100HPLM	KTIP1100HPLM	L	●

(Fortsetzung nächste Seite)

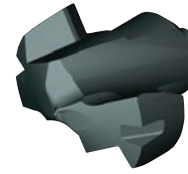
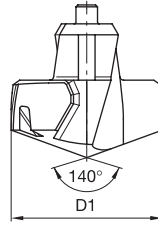

■ KTIP HPL(M)

(Fortsetzung von voriger Seite)

- Erste Wahl
- Alternative Wahl

H	■
S	■
N	■
K	■
M	●
P	■

D1		Bestellnummer	ISO-Katalognummer	ANSI-Katalognummer	Plattensitz-Größe/serie	KC7320
mm	Zoll					
11,10	0,4370	3557644	KTIP1110HPLM	KTIP1110HPLM	L	●
11,11	0,4375	3557773	KTIP1111HPLM	KTIP04375HPL	L	●
11,20	0,4409	3557645	KTIP1120HPLM	KTIP1120HPLM	L	●
11,40	0,4488	3557646	KTIP1140HPLM	KTIP1140HPLM	L	●
11,50	0,4528	3557647	KTIP1150HPLM	KTIP1150HPLM	M	●
11,60	0,4567	3557648	KTIP1160HPLM	KTIP1160HPLM	M	●
11,61	0,4571	3557774	KTIP1161HPLM	KTIP04571HPL	M	●
11,80	0,4646	3557649	KTIP1180HPLM	KTIP1180HPLM	M	●
11,90	0,4685	3557650	KTIP1190HPLM	KTIP1190HPLM	M	●
11,91	0,4688	3557775	KTIP1191HPLM	KTIP04688HPL	M	●
12,00	0,4724	3557651	KTIP1200HPLM	KTIP1200HPLM	N	●
12,10	0,4764	3557652	KTIP1210HPLM	KTIP1210HPLM	N	●
12,20	0,4803	3557653	KTIP1220HPLM	KTIP1220HPLM	N	●
12,30	0,4844	3557760	KTIP1230HPLM	KTIP04844HPL	N	●
12,50	0,4921	3557654	KTIP1250HPLM	KTIP1250HPLM	O	●
12,70	0,5000	3557761	KTIP1270HPLM	KTIP05000HPL	O	●
12,80	0,5039	3557655	KTIP1280HPLM	KTIP1280HPLM	O	●
12,90	0,5080	3557762	KTIP1290HPLM	KTIP05080HPL	O	●
13,00	0,5118	3557656	KTIP1300HPLM	KTIP1300HPLM	P	●
13,10	0,5156	3557763	KTIP1310HPLM	KTIP05156HPL	P	●
13,20	0,5197	3557657	KTIP1320HPLM	KTIP1320HPLM	P	●
13,49	0,5312	3557776	KTIP1349HPLM	KTIP05312HPL	P	●
13,50	0,5315	3557658	KTIP1350HPLM	KTIP1350HPLM	Q	●
13,80	0,5433	3557659	KTIP1380HPLM	KTIP1380HPLM	Q	●
13,89	0,5469	3557777	KTIP1389HPLM	KTIP05469HPL	Q	●
13,90	0,5471	3557764	KTIP1390HPLM	KTIP05471HPL	Q	●
13,90	0,5471	3557764	KTIP1390HPLM	KTIP05471HPL	Q	●
14,00	0,5512	3557660	KTIP1400HPLM	KTIP1400HPLM	R	●
14,10	0,5551	3557661	KTIP1410HPLM	KTIP1410HPLM	R	●
14,20	0,5591	3557662	KTIP1420HPLM	KTIP1420HPLM	R	●
14,29	0,5625	3557778	KTIP1429HPLM	KTIP05625HPL	R	●
14,30	0,5630	3557663	KTIP1430HPLM	KTIP1430HPLM	R	●
14,40	0,5669	3557664	KTIP1440HPLM	KTIP1440HPLM	R	●
14,50	0,5709	3557665	KTIP1450HPLM	KTIP1450HPLM	S	●
14,67	0,5774	3557779	KTIP1467HPLM	KTIP05774HPL	S	●
14,68	0,5781	3557780	KTIP1468HPLM	KTIP05781HPL	S	●
14,80	0,5827	3557666	KTIP1480HPLM	KTIP1480HPLM	S	●

(Fortsetzung nächste Seite)

VOLLHARTMETALL-BOHRER
 MODULARE BOHRER
 KOMBINATIONSWERKZEUGE
 HSS UND HARTMETALL-GEWINDEBOHRER
 WEINDEPLATTEN-BOHRER
 SENKWERKZEUGE
 BOHRUNGSFEINBEARBEITUNG
 SCHNEIDPLATTEN
 TECHNISCHE DATEN
 INDEX

KenTIP™ Vollhartmetall-Schneidkörper – Metrisch und Zoll

VOLLHARTMETALL-BOHRER

MODULARE BOHRER

KOMBINATIONSWERKZEUGE

HSS UND HARTMETALL-GEWINDEBOHRER

WENDEPLATTEN-BOHRER

SENKWERKZEUGE

BOHRUNGS-FEINBEARBEITUNG

SCHNEIDPLATTEN

TECHNISCHE DATEN

INDEX

■ KTIP HPL(M)

(Fortsetzung von voriger Seite)

- Erste Wahl
- Alternative Wahl

H	■
S	■
N	■
K	■
M	●
P	■

D1	mm		Bestellnummer	ISO-Katalognummer	ANSI-Katalognummer	Plattensitz-Größe/serie	KC7320
	Zoll						
15,00	0,5906		3548608	KTIP1500HPLM	KTIP1500HPLM	T	●
15,10	0,5945		3557667	KTIP1510HPLM	KTIP1510HPLM	T	●
15,20	0,5984		3557668	KTIP1520HPLM	KTIP1520HPLM	T	●
15,50	0,6102		3557669	KTIP1550HPLM	KTIP1550HPLM	T	●
15,88	0,6250		3557781	KTIP1588HPLM	KTIP06250HPL	T	●
16,00	0,6299		3557670	KTIP1600HPLM	KTIP1600HPLM	U	●
16,08	0,6330		3557782	KTIP1608HPLM	KTIP06330HPL	U	●
16,10	0,6339		3557671	KTIP1610HPLM	KTIP1610HPLM	U	●
16,50	0,6496		3557672	KTIP1650HPLM	KTIP1650HPLM	U	●
16,67	0,6562		3557783	KTIP1667HPLM	KTIP06562HPL	U	●
17,00	0,6693		3557673	KTIP1700HPLM	KTIP1700HPLM	V	●
17,48	0,6875		3557784	KTIP1748HPLM	KTIP06875HPL	V	●
17,50	0,6890		3557674	KTIP1750HPLM	KTIP1750HPLM	V	●
17,70	0,6969		3557675	KTIP1770HPLM	KTIP1770HPLM	V	●
18,00	0,7087		3557676	KTIP1800HPLM	KTIP1800HPLM	W	●
18,40	0,7244		3557677	KTIP1840HPLM	KTIP1840HPLM	W	●
18,50	0,7283		3557678	KTIP1850HPLM	KTIP1850HPLM	W	●
18,64	0,7344		3557785	KTIP1864HPLM	KTIP07344HPL	W	●
19,00	0,7480		3557679	KTIP1900HPLM	KTIP1900HPLM	X	●
19,05	0,7500		3557786	KTIP1905HPLM	KTIP07500HPL	X	●
19,10	0,7520		3557680	KTIP1910HPLM	KTIP1910HPLM	X	●
19,20	0,7559		3557681	KTIP1920HPLM	KTIP1920HPLM	X	●
19,23	0,7570		3557787	KTIP1923HPLM	KTIP07570HPL	X	●
19,25	0,7580		3557765	KTIP1925HPLM	KTIP07580HPL	X	●
19,28	0,7590		3557788	KTIP1928HPLM	KTIP07590HPL	X	●
19,35	0,7620		3557789	KTIP1935HPLM	KTIP07620HPL	X	●
19,46	0,7656		3557790	KTIP1946HPLM	KTIP07656HPL	X	●
19,50	0,7677		3557682	KTIP1950HPLM	KTIP1950HPLM	X	●
19,84	0,7812		3557791	KTIP1984HPLM	KTIP07812HPL	X	●
20,00	0,7874		3548609	KTIP2000HPLM	KTIP2000HPLM	J	●
20,24	0,7969		3557792	KTIP2024HPLM	KTIP07969HPL	J	●
20,50	0,8071		3557683	KTIP2050HPLM	KTIP2050HPLM	J	●
20,64	0,8125		3557793	KTIP2064HPLM	KTIP08125HPL	J	●
20,99	0,8264		3557684	KTIP2099HPLM	KTIP2099HPLM	J	●

Bestellbeispiel:

Nach Katalognummer: KTIP1500HPLM KC7320 oder nach Bestellnummer 3548608.

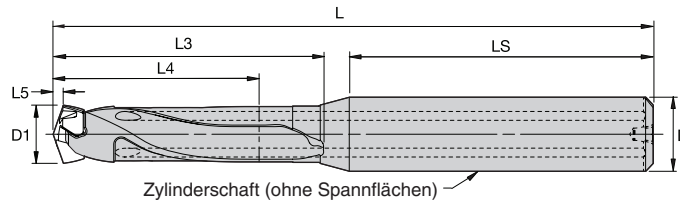

VOLLHARTMETALL-BOHRER

MODULARE BOHRER

KOMBINATIONEN WERKZEUGE

HSS UND HARTMETALL-GEWINDEBOHRER

WEINDEPLATTEN-BOHRER

SENKWERKZEUGE

BOHRUNGS-FEINBEARBEITUNG

SCHNEIDPLATTEN

TECHNISCHE DATEN

INDEX

- Grundkörper werden mit Montage-Schlüssel geliefert.

■ 3xD Grundkörper mit Zylinderschaft – Metrisch

mm		Zoll		Bestellnummer	Katalognummer	Plattensitzgröße Träger	D	L	L3	L4 max	L5	LS	Montage-Schlüssel
D1	D1 max	D1	D1 max										
8,00	8,49	.3125	.3343	2268303	KTIP080R3SS10M	F	10	79	35	26	1,4	41	170.306
8,50	8,99	.3346	.3539	2268304	KTIP085R3SS10M	G	10	81	37	27	1,5	41	170.306
9,00	9,49	.3543	.3736	2268305	KTIP090R3SS10M	H	10	83	39	29	1,6	41	170.306
9,50	9,99	.3740	.3933	2268306	KTIP095R3SS10M	I	10	85	41	30	1,6	41	170.306
10,00	10,49	.3937	.4130	2268307	KTIP100R3SS12M	J	12	92	43	32	1,7	46	170.307
10,50	10,99	.4134	.4327	2268308	KTIP105R3SS12M	K	12	94	45	33	1,8	46	170.307
11,00	11,49	.4331	.4524	2268309	KTIP110R3SS12M	L	12	96	47	35	1,9	46	170.307
11,50	11,99	.4528	.4720	2268310	KTIP115R3SS12M	M	12	98	49	36	2,0	46	170.307
12,00	12,49	.4724	.4917	2268311	KTIP120R3SS14M	N	14	101	52	38	2,1	46	170.308
12,50	12,99	.4921	.5114	2268312	KTIP125R3SS14M	O	14	103	54	39	2,2	46	170.308
13,00	13,49	.5118	.5311	2268313	KTIP130R3SS14M	P	14	105	56	41	2,2	46	170.308
13,50	13,99	.5315	.5508	2268314	KTIP135R3SS14M	Q	14	107	58	42	2,3	46	170.308
14,00	14,49	.5512	.5705	2268315	KTIP140R3SS16M	R	16	112	60	44	2,4	49	170.309
14,50	14,99	.5709	.5902	2268316	KTIP145R3SS16M	S	16	114	62	45	2,5	49	170.309
15,00	15,99	.5906	.6295	2268317	KTIP150R3SS16M	T	16	118	66	48	2,6	49	170.309
16,00	16,99	.6299	.6689	2268318	KTIP160R3SS18M	U	18	122	70	51	2,8	49	170.309
17,00	17,99	.6693	.7083	3017663	KTIP170R3SS18M	V	18	127	75	54	2,9	49	170.314
18,00	18,99	.7087	.7476	3017664	KTIP180R3SS20M	W	20	133	79	57	3,1	51	170.314
19,00	19,99	.7480	.7870	3017665	KTIP190R3SS20M	X	20	137	83	60	3,3	51	170.314
20,00	20,99	.7874	.8264	3017666	KTIP200R3SS25M	Y	25	147	87	63	3,4	57	170.314

Bestellbeispiel:

Nach Katalognummer KTIP080R3SS10M, oder nach Bestellnummer 2268303.

KenTIP™ Grundkörper mit Zylinderschaft – Metrisch

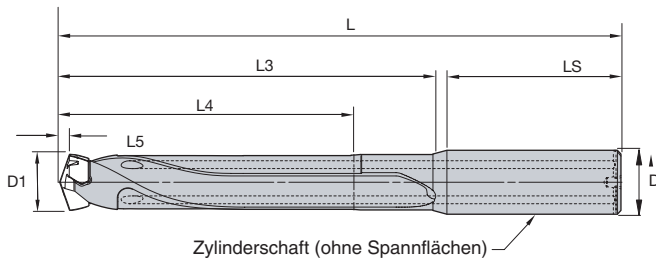

- Grundkörper werden mit Montage-Schlüssel geliefert.

■ 5xD Grundkörper mit Zylinderschaft – Metrisch

mm		Zoll		Bestellnummer	Katalognummer	Plattensitzgröße Träger	D	L	L3	L4 max	L5	LS	Montage-Schlüssel
D1	D1 max	D1	D1 max										
8,00	8,49	.3125	.3343	2258040	KTIP080R5SS10M	F	10	97	53	43	1,4	41	170.306
8,50	8,99	.3346	.3539	2402283	KTIP085R5SS10M	G	10	100	56	45	1,5	41	170.306
9,00	9,49	.3543	.3736	2402284	KTIP090R5SS10M	H	10	103	59	48	1,6	41	170.306
9,50	9,99	.3740	.3933	2402285	KTIP095R5SS10M	I	10	107	63	50	1,6	41	170.306
10,00	10,49	.3937	.4130	2258041	KTIP100R5SS12M	J	12	115	66	53	1,7	46	170.307
10,50	10,99	.4134	.4327	2402286	KTIP105R5SS12M	K	12	118	69	55	1,8	46	170.307
11,00	11,49	.4331	.4524	2402287	KTIP110R5SS12M	L	12	121	72	58	1,9	46	170.307
11,50	11,99	.4528	.4720	2402288	KTIP115R5SS12M	M	12	124	75	60	2,0	46	170.307
12,00	12,49	.4724	.4917	2258042	KTIP120R5SS14M	N	14	127	78	63	2,1	46	170.308
12,50	12,99	.4921	.5114	2402289	KTIP125R5SS14M	O	14	130	81	65	2,2	46	170.308
13,00	13,49	.5118	.5311	2402290	KTIP130R5SS14M	P	14	133	84	68	2,2	46	170.308
13,50	13,99	.5315	.5508	2402291	KTIP135R5SS14M	Q	14	137	88	70	2,3	46	170.308
14,00	14,49	.5512	.5705	2402292	KTIP140R5SS16M	R	16	143	91	73	2,4	49	170.309
14,50	14,99	.5709	.5902	2402293	KTIP145R5SS16M	S	16	146	94	75	2,5	49	170.309
15,00	15,99	.5906	.6295	2402294	KTIP150R5SS16M	T	16	152	100	80	2,6	49	170.309
16,00	16,99	.6299	.6689	2258053	KTIP160R5SS18M	U	18	158	106	85	2,8	49	170.309
17,00	17,99	.6693	.7083	3017671	KTIP170R5SS18M	V	18	165	113	90	2,9	49	170.314
18,00	18,99	.7087	.7476	3017672	KTIP180R5SS20M	W	20	173	119	95	3,1	51	170.314
19,00	19,99	.7480	.7870	3017673	KTIP190R5SS20M	X	20	179	125	100	3,3	51	170.314
20,00	20,99	.7874	.8264	3017674	KTIP200R5SS25M	Y	25	191	131	105	3,4	57	170.314

Bestellbeispiel:

Nach Katalognummer KTIP080R5SS10M, oder nach Bestellnummer 2258040.

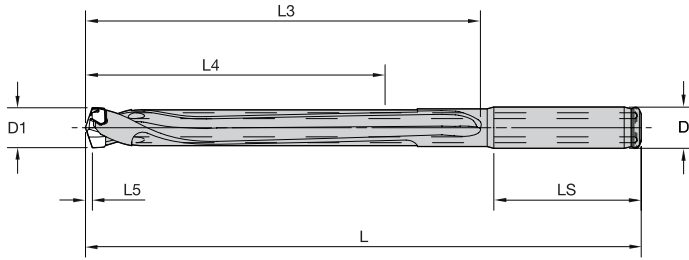

- Grundkörper werden mit Montage-Schlüssel geliefert.

■ 8xD Grundkörper mit Zylinderschaft – Metrisch

mm		Zoll		Bestellnummer	Katalognummer	Plattensitzgröße Träger	D	L	L3	L4 max	L5	LS	Montage-Schlüssel
D1	D1 max	D1	D1 max										
8,00	8,49	.3150	.3343	2548776	KTIP080R8SS10M	F	10	123	78	68	1,4	41	170.306
8,50	8,99	.3346	.3539	2440526	KTIP085R8SS10M	G	10	127	83	72	1,5	41	170.306
9,00	9,49	.3543	.3736	2548777	KTIP090R8SS10M	H	10	132	87	76	1,6	41	170.306
9,50	9,99	.3740	.3933	2548778	KTIP095R8SS10M	I	10	137	92	80	1,6	41	170.306
10,00	10,49	.3937	.4130	2548779	KTIP100R8SS12M	J	12	147	97	84	1,7	46	170.307
10,50	10,99	.4134	.4327	2548780	KTIP105R8SS12M	K	12	151	101	88	1,8	46	170.307
11,00	11,49	.4331	.4524	2548781	KTIP110R8SS12M	L	12	156	105	92	1,9	46	170.307
11,50	11,99	.4528	.4720	2548782	KTIP115R8SS12M	M	12	160	110	96	2,0	46	170.307
12,00	12,49	.4724	.4917	2548913	KTIP120R8SS14M	N	14	165	115	100	2,1	46	170.308
12,50	12,99	.4921	.5114	2548914	KTIP125R8SS14M	O	14	169	119	104	2,2	46	170.308
13,00	13,49	.5118	.5311	2548915	KTIP130R8SS14M	P	14	174	123	108	2,2	46	170.308
13,50	13,99	.5315	.5508	2548916	KTIP135R8SS14M	Q	14	179	129	112	2,3	46	170.308
14,00	14,49	.5512	.5705	2548917	KTIP140R8SS16M	R	16	187	133	116	2,4	49	170.309
14,50	14,99	.5709	.5902	2548918	KTIP145R8SS16M	S	16	191	138	120	2,5	49	170.309
15,00	15,99	.5906	.6295	2548919	KTIP150R8SS16M	T	16	200	147	128	2,6	49	170.309
16,00	16,99	.6299	.6689	2440527	KTIP160R8SS18M	U	18	209	155	136	2,8	49	170.309
17,00	17,99	.6690	.7083	3114313	KTIP170R8SS18M	V	18	219	166	144	2,9	49	170.314
18,00	18,99	.7090	.7476	3114314	KTIP180R8SS20M	W	20	230	175	152	3,1	51	170.314
19,00	19,99	.7480	.7870	3114315	KTIP190R8SS20M	X	20	239	184	160	3,3	51	170.314
20,00	20,99	.7870	.8264	3114316	KTIP200R8SS25M	Y	25	254	196	168	3,4	57	170.314

Bestellbeispiel:

Nach Katalognummer KTIP080R8SS10M, oder nach Bestellnummer 2548776.

KenTIP™ Grundkörper Zylinderschaft mit Flansch – Metrisch

VOLLHARTMETALL-BOHRER

MODULARE BOHRER

KOMBINATIONSWERKZEUGE

HSS UND HARTMETALL-GEWINDEBOHRER

WENDEPLATTEN-BOHRER

SENKWERKZEUGE

BOHRUNGS-FEINBEARBEITUNG

SCHNEIDPLATTEN

TECHNISCHE DATEN

INDEX

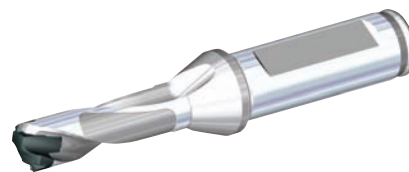
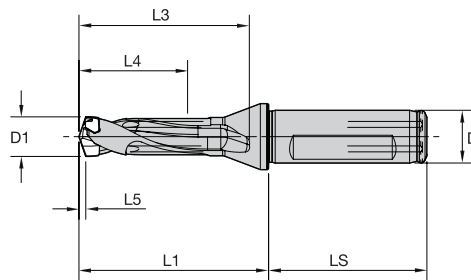

- Grundkörper werden mit Montage-Schlüssel geliefert.

■ 3xD Grundkörper Zylinderschaft mit Flansch – Metrisch

mm		Zoll		Bestellnummer	Katalognummer	Plattensitzgröße Träger	D	L	L1	L3	L4 max	L5	LS	Montage-Schlüssel
D1	D1 max	D1	D1 max											
8,00	8,49	.3125	.3343	2405161	KTIP080R3SCF12M	F	12	86	41	35	26	1,4	45	170.306
8,50	8,99	.3346	.3539	2405162	KTIP085R3SCF12M	G	12	88	43	37	27	1,5	45	170.306
9,00	9,49	.3543	.3736	2405203	KTIP090R3SCF12M	H	12	90	45	39	29	1,6	45	170.306
9,50	9,99	.3740	.3933	2405204	KTIP095R3SCF12M	I	12	92	47	41	30	1,6	45	170.306
10,00	10,49	.3937	.4130	2405205	KTIP100R3SCF16M	J	16	97	49	43	32	1,7	48	170.307
10,50	10,99	.4134	.4327	2405206	KTIP105R3SCF16M	K	16	99	51	45	33	1,8	48	170.307
11,00	11,49	.4331	.4524	2405207	KTIP110R3SCF16M	L	16	101	53	47	35	1,9	48	170.307
11,50	11,99	.4528	.4720	2405208	KTIP115R3SCF16M	M	16	103	55	49	36	2,0	48	170.307
12,00	12,49	.4724	.4917	2405209	KTIP120R3SCF16M	N	16	106	58	52	38	2,1	48	170.308
12,50	12,99	.4921	.5114	2405210	KTIP125R3SCF16M	O	16	108	60	54	39	2,2	48	170.308
13,00	13,49	.5118	.5311	2405211	KTIP130R3SCF16M	P	16	110	62	56	41	2,2	48	170.308
13,50	13,99	.5315	.5508	2405212	KTIP135R3SCF16M	Q	16	112	64	58	42	2,3	48	170.308
14,00	14,49	.5512	.5705	2405213	KTIP140R3SCF16M	R	16	114	66	60	44	2,4	48	170.309
14,50	14,99	.5709	.5902	2405214	KTIP145R3SCF16M	S	16	116	68	62	45	2,5	48	170.309
15,00	15,99	.5906	.6295	2405215	KTIP150R3SCF20M	T	20	122	72	66	48	2,6	50	170.309
16,00	16,99	.6299	.6689	2405216	KTIP160R3SCF20M	U	20	126	76	70	51	2,8	50	170.309
17,00	17,99	.6693	.7083	3017667	KTIP170R3SCF20M	V	20	131	81	75	54	2,9	50	170.314
18,00	18,99	.7087	.7476	3017668	KTIP180R3SCF25M	W	25	141	85	79	57	3,1	56	170.314
19,00	19,99	.7480	.7870	3017669	KTIP190R3SCF25M	X	25	144	89	83	60	3,3	56	170.314
20,00	20,99	.7874	.8264	3017670	KTIP200R3SCF25M	Y	25	149	93	87	63	3,4	56	170.314

Bestellbeispiel:

Nach Katalognummer KTIP080R3SCF12M , oder nach Bestellnummer 2405161.

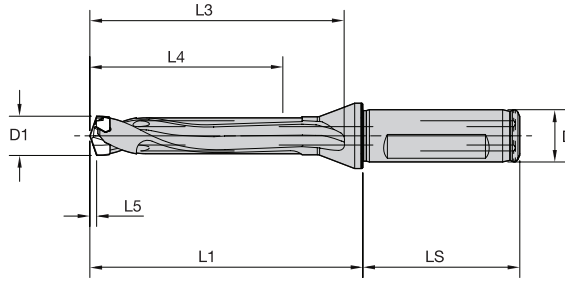

- Grundkörper werden mit Montage-Schlüssel geliefert.

■ 5xD Grundkörper Zylinderschaft mit Flansch – Metrisch

mm		Zoll		Bestellnummer	Katalognummer	Plattensitzgröße Träger	D	L	L1	L3	L4 max	L5	LS	Montage-Schlüssel
D1	D1 max	D1	D1 max											
8,00	8,49	.3125	.3343	2405248	KTIP080R5SCF12M	F	12	104	59	53	43	1,4	45	170.306
8,50	8,99	.3346	.3539	2405249	KTIP085R5SCF12M	G	12	107	62	56	45	1,5	45	170.306
9,00	9,49	.3543	.3736	2405250	KTIP090R5SCF12M	H	12	110	65	59	48	1,6	45	170.306
9,50	9,99	.3740	.3933	2405251	KTIP095R5SCF12M	I	12	114	69	63	50	1,6	45	170.306
10,00	10,49	.3937	.4130	2405252	KTIP100R5SCF16M	J	16	120	72	66	53	1,7	48	170.307
10,50	10,99	.4134	.4327	2405273	KTIP105R5SCF16M	K	16	123	75	69	55	1,8	48	170.307
11,00	11,49	.4331	.4524	2405274	KTIP110R5SCF16M	L	16	126	78	72	58	1,9	48	170.307
11,50	11,99	.4528	.4720	2405275	KTIP115R5SCF16M	M	16	129	81	75	60	2,0	48	170.307
12,00	12,49	.4724	.4917	2405276	KTIP120R5SCF16M	N	16	132	84	78	63	2,1	48	170.308
12,50	12,99	.4921	.5114	2405277	KTIP125R5SCF16M	O	16	135	87	81	65	2,2	48	170.308
13,00	13,49	.5118	.5311	2405278	KTIP130R5SCF16M	P	16	138	90	84	68	2,2	48	170.308
13,50	13,99	.5315	.5508	2405279	KTIP135R5SCF16M	Q	16	142	94	88	70	2,3	48	170.308
14,00	14,49	.5512	.5705	2405280	KTIP140R5SCF16M	R	16	145	97	91	73	2,4	48	170.309
14,50	14,99	.5709	.5902	2405281	KTIP145R5SCF16M	S	16	148	100	94	75	2,5	48	170.309
15,00	15,99	.5906	.6295	2405282	KTIP150R5SCF20M	T	20	156	106	100	80	2,6	50	170.309
16,00	16,99	.6299	.6689	2405283	KTIP160R5SCF20M	U	20	162	112	106	85	2,8	50	170.309
17,00	17,99	.6693	.7083	3017675	KTIP170R5SCF20M	V	20	169	119	113	90	2,9	50	170.314
18,00	18,99	.7087	.7476	3017676	KTIP180R5SCF25M	W	25	181	125	119	95	3,1	56	170.314
19,00	19,99	.7480	.7870	3017677	KTIP190R5SCF25M	X	25	187	131	125	100	3,3	56	170.314
20,00	20,99	.7874	.8264	3017678	KTIP200R5SCF25M	Y	25	193	137	131	105	3,4	56	170.314

Bestellbeispiel:

Nach Katalognummer KTIP080R5SCF12M , oder nach Bestellnummer 2405248.

KenTIP™ Grundkörper Zylinderschaft mit Flansch – Metrisch

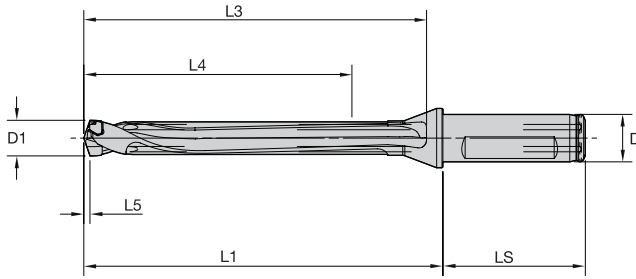

- Grundkörper werden mit Montage-Schlüssel geliefert.

■ 8xD Grundkörper Zylinderschaft mit Flansch – Metrisch

mm		Zoll		Bestellnummer	Katalognummer	Plattensitzgröße Träger	D	L	L1	L3	L4 max	L5	LS	Montage-Schlüssel
D1	D1 max	D1	D1 max											
8,00	8,49	.3150	.3343	2548920	KTIP080R8SCF12M	F	12	129	84	79	68	1,4	45	170.306
8,50	8,99	.3346	.3539	2548921	KTIP085R8SCF12M	G	12	134	89	83	72	1,5	45	170.306
9,00	9,49	.3543	.3736	2548922	KTIP090R8SCF12M	H	12	138	93	88	76	1,6	45	170.306
9,50	9,99	.3740	.3933	2548923	KTIP095R8SCF12M	I	12	144	99	93	80	1,6	45	170.306
10,00	10,49	.3937	.4130	2548924	KTIP100R8SCF16M	J	16	151	103	97	84	1,7	48	170.307
10,50	10,99	.4134	.4327	2548925	KTIP105R8SCF16M	K	16	156	108	102	88	1,8	48	170.307
11,00	11,49	.4331	.4524	2548926	KTIP110R8SCF16M	L	16	160	112	107	92	1,9	48	170.307
11,50	11,99	.4528	.4720	2548927	KTIP115R8SCF16M	M	16	165	117	111	96	2,0	48	170.307
12,00	12,49	.4724	.4917	2548928	KTIP120R8SCF16M	N	16	169	121	116	100	2,1	48	170.308
12,50	12,99	.4921	.5114	2548929	KTIP125R8SCF16M	O	16	174	126	120	104	2,2	48	170.308
13,00	13,49	.5118	.5311	2548930	KTIP130R8SCF16M	P	16	178	130	124	108	2,2	48	170.308
13,50	13,99	.5315	.5508	2548931	KTIP135R8SCF16M	Q	16	184	136	130	112	2,3	48	170.308
14,00	14,49	.5512	.5705	2548932	KTIP140R8SCF16M	R	16	188	140	134	116	2,4	48	170.309
14,50	14,99	.5709	.5902	2548933	KTIP145R8SCF16M	S	16	193	145	139	120	2,5	48	170.309
15,00	15,99	.5906	.6295	2548934	KTIP150R8SCF20M	T	20	204	154	148	128	2,6	50	170.309
16,00	16,99	.6299	.6689	2548935	KTIP160R8SCF20M	U	20	213	163	157	136	2,8	50	170.309
17,00	17,99	.6690	.7083	3114317	KTIP170R8SCF20M	V	20	223	173	167	144	2,9	50	170.314
18,00	18,99	.7090	.7476	3114318	KTIP180R8SCF25M	W	25	238	182	176	152	3,1	56	170.314
19,00	19,99	.7480	.7870	3114319	KTIP190R8SCF25M	X	25	247	191	185	160	3,3	56	170.314
20,00	20,99	.7870	.8264	3114320	KTIP200R8SCF25M	Y	25	256	200	194	168	3,4	56	170.314

Bestellbeispiel:

Nach Katalognummer KTIP080R8SCF12M , oder nach Bestellnummer 2548920.

Montage der KenTIP-Schneidkörper

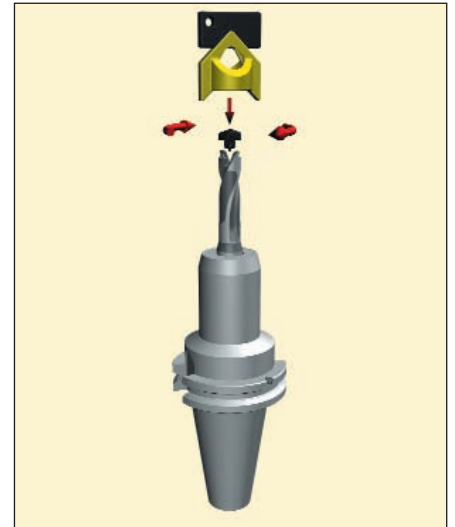
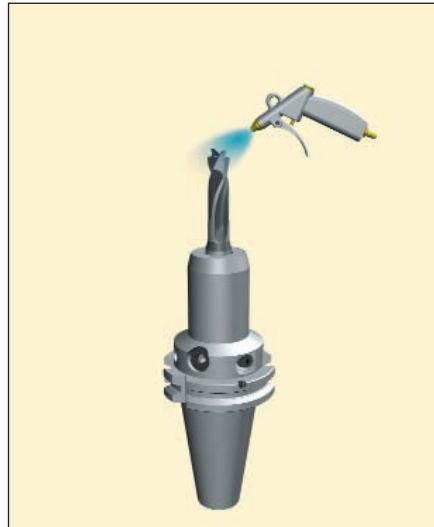
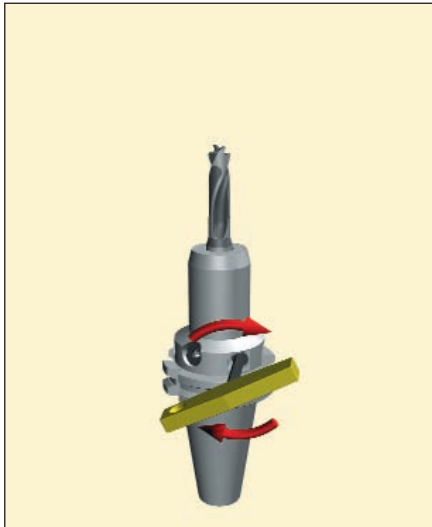

Kühlung des KenTIP-Bohrers

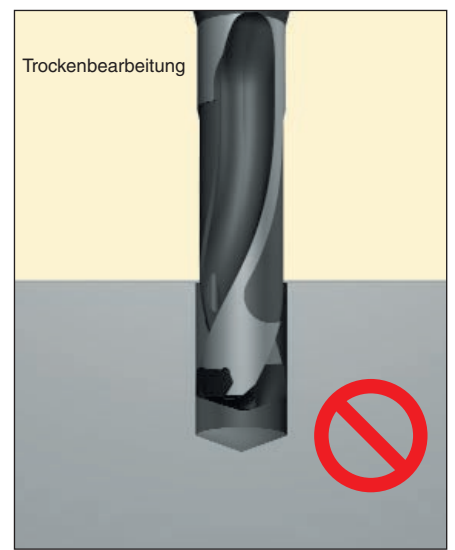
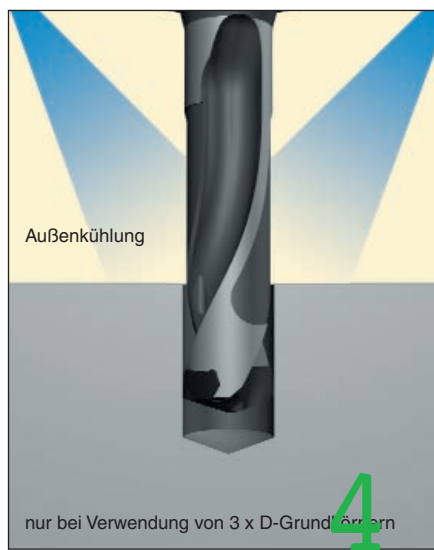
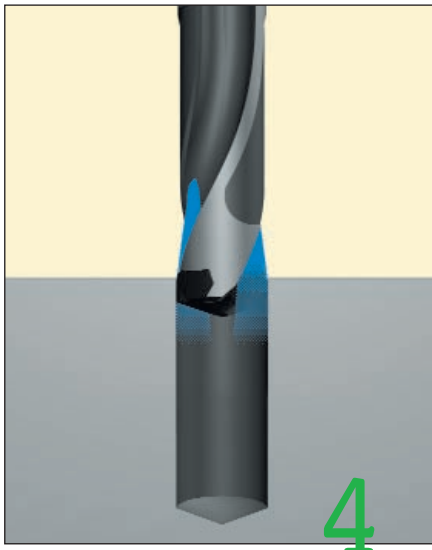

Hinweis

