

MTAR

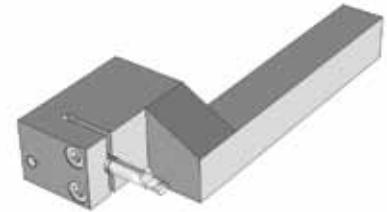

Haltertyp										Référence	Type of holder	MTAR...
S	∅D	L	L ₁	L ₂	L ₃	B ₁	B ₂	H	Ident. N°			
7	4	31	100	34	13	35	15	16	...07100/431	△		
8	4	26	100	34	13	29	8	16	...08100/426	●		
8	4	31	100	34	13	35	15	16	...08100/431	●		
10	4	26	100	34	13	29	8	16	...10100/426	●		
10	4	31	100	34	13	35	15	16	...10100/431	●		
10	4	36	100	34	13	40	20	16	...10100/436	○		
10	6	35	100	34	13	38	14	16	...10100/635	●		
10	6	43	100	34	13	45	21	16	...10100/643	●		
10	6	48	100	34	13	50	26	16	...10100/648	●		
12	4	26	100	34	13	29	8	16	...12100/426	●		
12	4	31	100	34	13	35	15	16	...12100/431	●		
12	4	36	100	34	13	40	20	16	...12100/436	●		
12	6	35	100	34	13	38	14	16	...12100/635	●		
12	6	43	100	34	13	45	21	16	...12100/643	●		
12	6	48	100	34	13	50	26	16	...12100/648	●		
12	6	53	100	34	13	55	33	16	...12100/653	●		
16	4	31	130	34	13	35	15	16	...16130/431	●		
16	4	36	130	34	13	40	20	16	...16130/436	○		
16	6	35	130	34	13	38	14	16	...16130/635	○		
16	6	43	130	34	13	45	21	16	...16130/643	●		
16	6	48	130	34	13	50	26	16	...16130/648	●		
16	6	53	130	38	17	55	33	16	...16130/653	●		
16	6	61	130	38	17	64	42	16	...16130/661	○		
16	6	71	130	38	17	74	52	16	...16130/671	○		

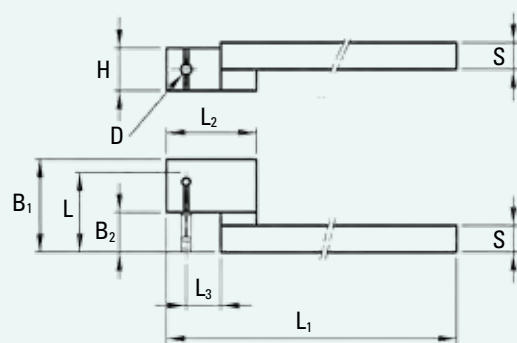

MTAL

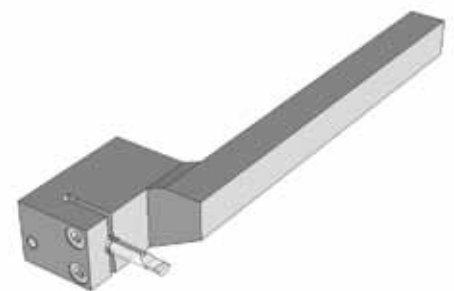

Haltertyp										Référence	Type of holder	MTAL...
S	∅D	L	L ₁	L ₂	L ₃	B ₁	B ₂	H	Ident. N°			
7	4	31	120	34	13	35	15	16	...07120/4	△		
8	4	31	130	34	13	35	15	16	...08130/4	△		
10	6	43	130	34	13	45	21	16	...10130/6	△		
12	4	31	130	34	13	35	15	16	...12130/4	○		
12	6	43	130	34	13	45	21	16	...12130/6	△		
16	4	31	150	34	13	35	15	16	...16150/4	△		
16	6	43	150	34	13	45	21	16	...16150/6	△		

△ Solange Vorrat

△ Jusqu'à épuisement du stock

△ Until use up of stock

Gekröpfte Halter, neutral, ohne Kühlkanal

Porte-outils coudés neutres, sans arrosage

Cranked holders, neutral, without coolant capability

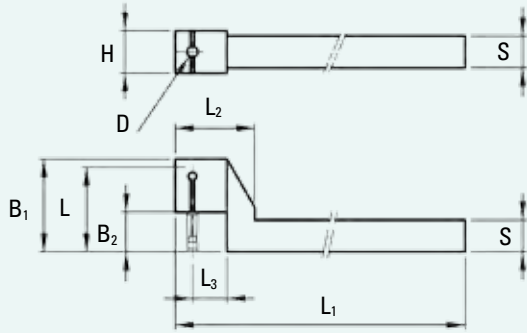

MTAN

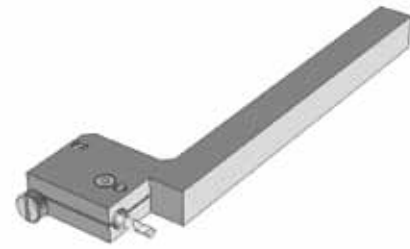

Werkzeugtyp		Référence			Type of holder				Ident. N°
S	∅D	L	L ₁	L ₂	L ₃	B ₁	B ₂	H	
8	4	26	98	18,5	9,5	28,5	8	8	...08098/426
8	4	31	98	18,5	9,5	33,5	8	8	...08098/431
10	4	26	98	25,5	13	29	8	8	...10098/426
10	4	31	98	25,5	13	33,5	8	8	...10098/431
12	4	26	128	25,5	13	29	8	8	...12128/426
12	4	31	128	25,5	13	35	15	8	...12128/431

MTAN...	
●*	
●*	
●	
●	
●	
●	

* auch für / aussi pour / as well as for Citizen R04/R07

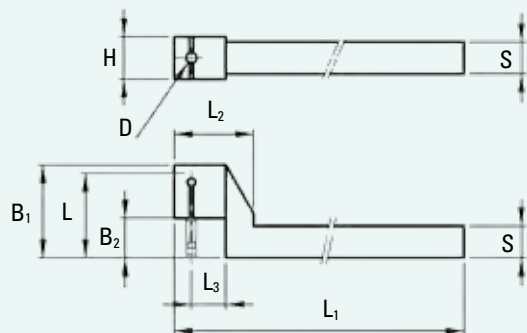

MTAN

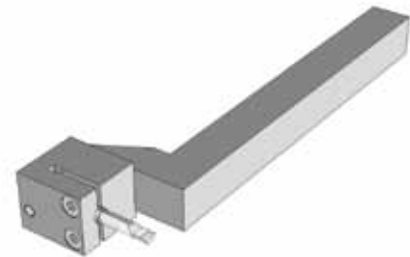

Werkzeugtyp		Référence			Type of holder				Ident. N°
S	∅D	L	L ₁	L ₂	L ₃	B ₁	B ₂	H	
8	4	26	100	21	7,5	29	8	16	...08100/426
8	4	31	100	21	7,5	35	15	16	...08100/431
10	4	26	100	21	7,5	29	8	16	...10100/426
10	4	31	100	30	13	35	15	16	...10100/431
10	4	36	100	30	13	40	20	16	...10100/436
10	6	35	100	30	13	37	14	16	...10100/635
10	6	43	100	30	13	45	21	16	...10100/643
10	6	48	100	30	13	50	26	16	...10100/648
12	4	26	130	21	7,5	29	8	16	...12130/426
12	4	31	130	30	13	35	15	16	...12130/431
12	4	36	130	30	13	40	20	16	...12130/436
12	6	35	130	30	13	37	14	16	...12130/635
12	6	43	130	30	13	45	21	16	...12130/643
12	6	48	130	30	13	50	26	16	...12130/648
12	6	53	130	30	13	55	33	16	...12130/653
16	4	31	130	34	13	35	15	16	...16130/431
16	4	36	130	34	13	40	20	16	...16130/436
16	6	35	130	34	13	37	14	16	...16130/635
16	6	43	130	34	13	45	21	16	...16130/643
16	6	48	130	34	13	50	26	16	...16130/648
16	6	53	130	38	17	55	33	16	...16130/653
16	6	61	130	38	17	64	42	16	...16130/661
16	6	71	130	38	17	74	52	16	...16130/671

MTAN...	
●	
●	
●	
●	
○	
●	
●	
●	
●	
●	
●	
○	
○	
○	

Bestell-Nr.: entsprechenden Werkzeugtyp und Ident.-Nr. zusammenfügen, z.B.: MTAN-08098/426

- Lieferbar ab Lager
- Lieferfrist auf Anfrage

N° de commande: joindre le numéro d'identification à la référence, par exemple: MTAN-08098/426

- Livrable du stock
- Délai de livraison sur demande

Order number: Add Ident. No. to type of tool, e.g.: MTAN-08098/426

- Available ex stock
- Delivery time on request

Gekröpfte Halter, neutral,
mit Kühlkanal

Porte-outils coudés neutres,
avec arrosage

Cranked holders, neutral, with
through coolant capability

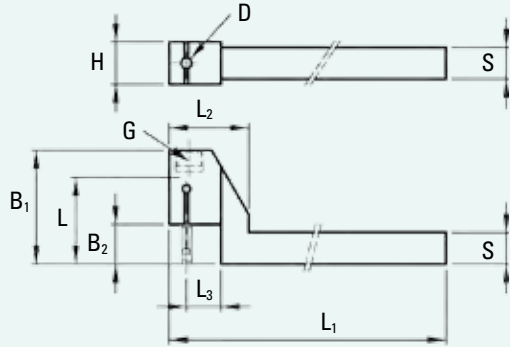

G = G 1/8"

MTAN

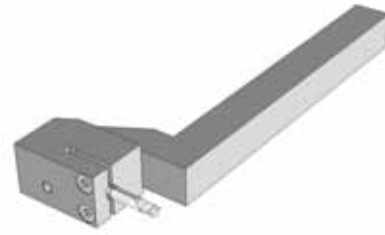

Werkzeugtyp		Référence			Type of holder			MTAN...	
S	∅D	L	L ₁	L ₂	L ₃	B ₁	B ₂	H	Ident. N°
12	4	31	130	30	13	43	15	16	...12131/431
12	4	36	130	30	13	48	20	16	...12131/436
12	6	43	130	30	13	53	21	16	...12131/643
12	6	48	130	30	13	58	26	16	...12131/648
12	6	53	130	30	13	63	33	16	...12131/653
16	4	31	130	34	13	43	15	16	...16131/431
16	4	36	130	34	13	48	20	16	...16131/436
16	6	43	130	34	13	53	21	16	...16131/643
16	6	48	130	34	13	58	26	16	...16131/648
16	6	53	130	34	17	63	33	16	...16131/653

Positionierhilfe MTAP zu Halter MT.../426 siehe Seite 34

Jauge de positionnement MTAP pour porte-outils MT... /426 voir page 34

Positioning tool MTAP for tool-holders MT... /426 see page 34



Bestell-Nr.: entsprechenden Werkzeugtyp und Ident.-Nr. zusammenfügen, z.B.: MTAN-12131/431

- Lieferbar ab Lager
- Lieferfrist auf Anfrage

N° de commande: joindre le numéro d'identification à la référence, par exemple: MTAN-12131/431

- Livrable du stock
- Délai de livraison sur demande

Order number: Add ident. No. to type of tool, e.g.: MTAN-12131/431

- Available ex stock
- Delivery time on request

MTAA



Verwendung / Utilisation / Utilization		MTAA...
	Ident. N°	
für / pour / for MTAR... / MTAL... / MTAD-01000/...	...00000	●
für / pour / for MTAD-01002/...	...01002	●
für / pour / for MTAD-01300/...	...01300	●

MTAP



Verwendung / Utilisation / Utilization		MTAP-00426
für / pour / for MTA... /426		●

Bestell-Nr.: entsprechenden Werkzeugtyp und Ident.-Nr. zusammenfügen, z.B.: MTAA-00000

- Lieferbar ab Lager
- Lieferfrist auf Anfrage

N° de commande: joindre le numéro d'identification à la référence, par exemple: MTAA-00000

- Livrable du stock
- Délai de livraison sur demande

Order number: Add Ident. No. to type of tool, e.g.: MTAA-00000

- Available ex stock
- Delivery time on request